



TERMA

SINCE 1990

Passo

SPARKLING GREY // 1800 — 780 // 50 mm connection valve + “Noble” thermostatic head

LUX





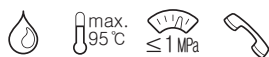

Standard connections:



Sizes available:

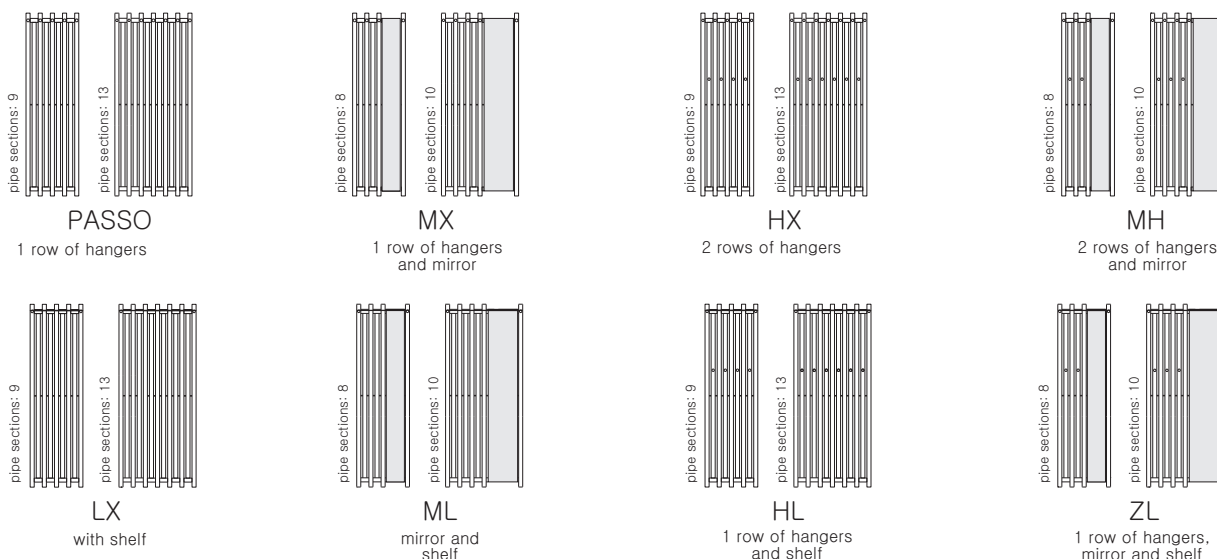

A	B	C	C'	C''	$\frac{75^\circ}{65^\circ}$ 20°	$\frac{55^\circ}{45^\circ}$ 20°		D	E	F		
[mm]	[mm]	[mm]	[mm]	[mm]	[W]	[W]	[W]	[mm]	[mm]	[mm]	[dm²]	[Kg]
PASSO (1 row of hangers)												
1800	520	50	480	520	889	454	-	420	1660	70	4,7	18,0
1800	760	50	720	760	1275	651	-	660	1660	70	6,1	23,6
MX (1 row of hangers and mirror)												
1800	520	50	480	520	752	384	-	420	1660	70	5,2	20,3
1800	760	50	720	760	958	489	-	660	1660	70	7,5	29,8
HX (2 rows of hangers)												
1800	520	50	480	520	889	454	-	420	1660	70	4,7	18,0
1800	760	50	720	760	1275	651	-	660	1660	70	6,1	23,6
MH (2 rows of hangers and mirror)												
1800	520	50	480	520	752	384	-	420	1660	70	5,2	20,3
1800	760	50	720	760	958	489	-	660	1660	70	7,5	29,8
LX (with shelf)												
1800	520	50	480	520	889	454	-	420	1660	70	4,7	18,0
1800	760	50	720	760	1275	651	-	660	1660	70	6,1	23,6
ML (mirror and shelf)												
1800	520	50	480	520	752	384	-	420	1660	70	5,2	20,3
1800	760	50	720	760	958	489	-	660	1660	70	7,5	29,8
HL (1 row of hangers and shelf)												
1800	520	50	480	520	889	454	-	420	1620	90	4,7	18,0
1800	760	50	720	760	1275	651	-	660	1620	90	6,1	23,6
ZL (1 row of hangers, mirror and shelf)												
1800	520	50	480	520	752	384	-	420	1620	90	5,2	20,3
1800	760	50	720	760	958	489	-	660	1620	90	7,5	29,8

P2

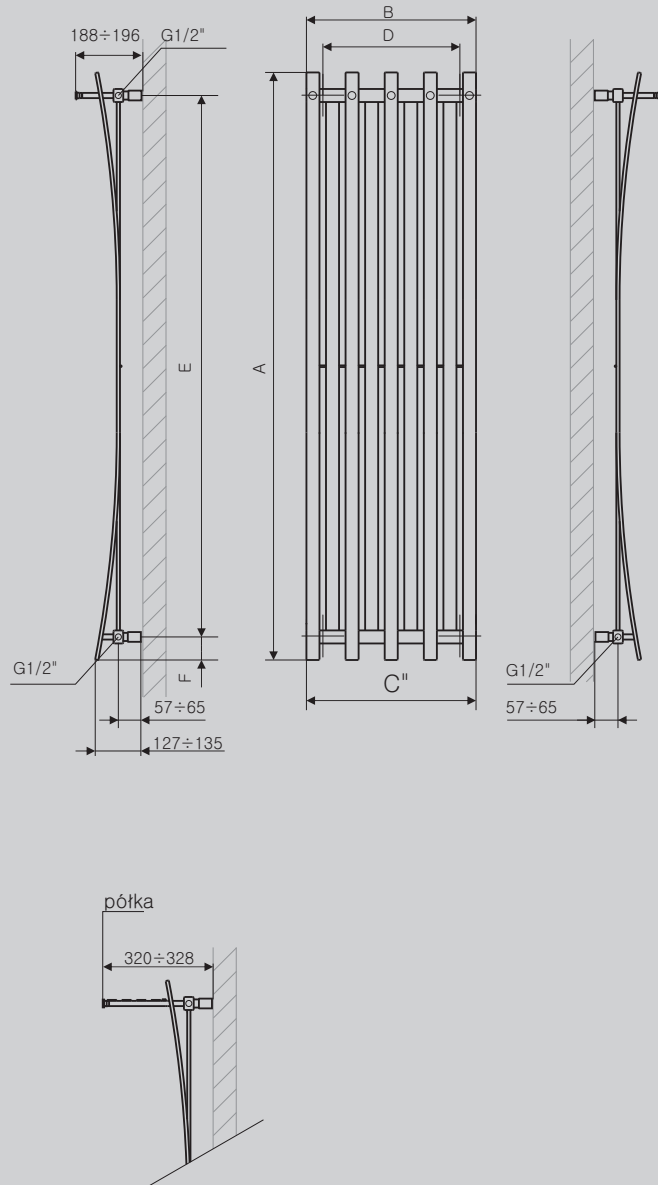

ZX

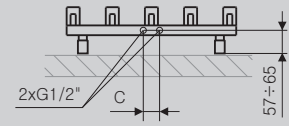

SX

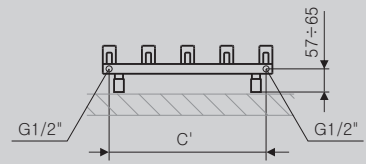

YL

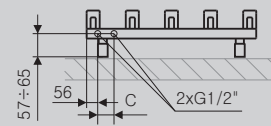

YP

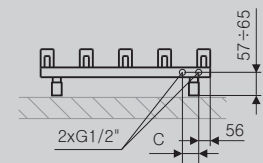

Radiator Collector

Profile

