

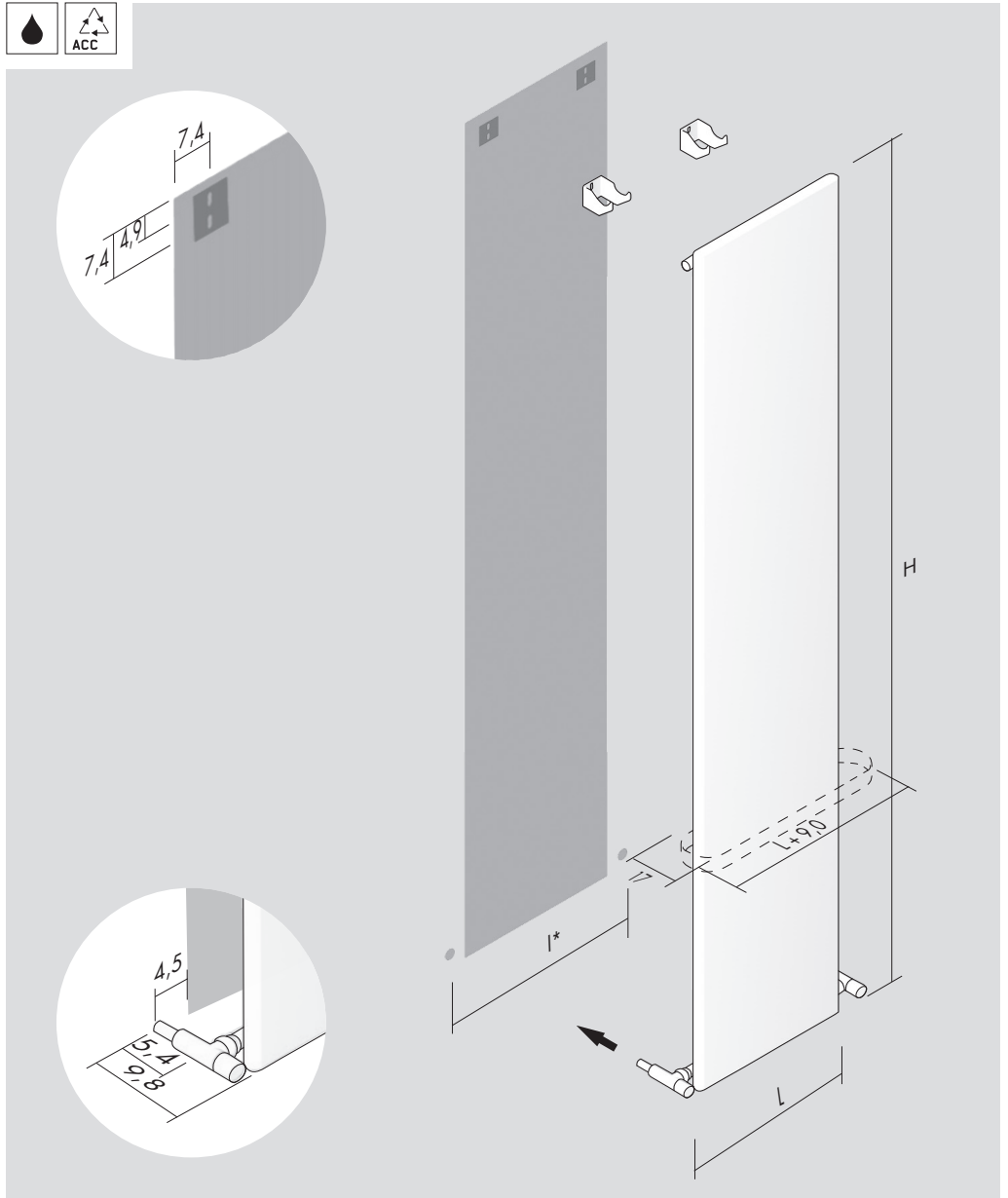

Kcal = Watt x 0.860
BTU = Watt x 3.413

Watt Δt 60° = Watt Δt 50° x 1.264
Watt Δt 40° = Watt Δt 50° x 0.750
Watt Δt 30° = Watt Δt 50° x 0.518
Watt Δt 20° = Watt Δt 50° x 0.307

p max = 10.0 bar



Standard connection / Raccord standard
Standard Anschluss / Conexión estándar

[X]

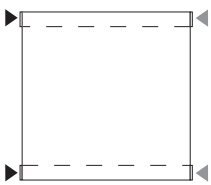

[XM_]

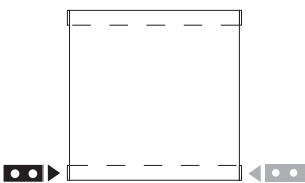

Special connection / Raccord spéciale / Speziell Anschluss / Conexión especial

[B]

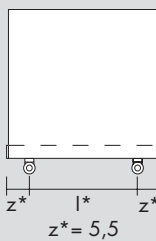

[E]

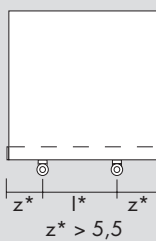

[S]

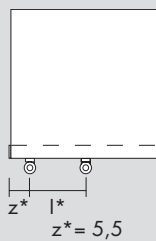

[D]

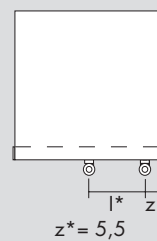

[PS]

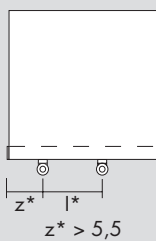

[PD]

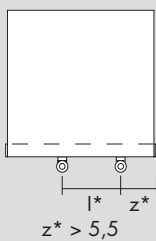

[5]

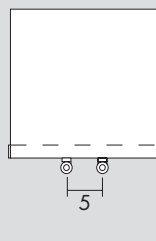

[5_]

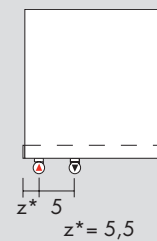

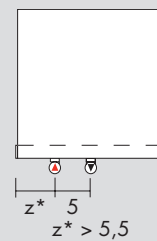

[P5_]







Replace _ with connection S (Left) or D (Right). / Remplacer le _ avec raccordement S (Gauche) ou D (Droite). /
Um linker oder rechter Anschluss zu bestellen, bitte das Symbol _ mit S (links) oder D (rechts) ersetzen. /
Sustituir el _ con las conexiones S (Izquierda) o D (Derecha).

I* = pipe centres / distance entre depart et retour / Achsabstand / distancia entre las conexiones

H cm	L cm				art*	Lt*	watt Δt 30°	watt Δt 50°
63.0	83.0	56.0	89.0		TV255063022_	6.5	278	537
103.0	39.8	96.0	45.8		TV255103010_	4.6	200	387
103.0	54.2	96.0	60.2		TV255103014_	6.4	281	542
123.0	39.8	116.0	45.8		TV255123010_	5.4	237	457
123.0	54.2	116.0	60.2		TV255123014_	7.5	332	640
153.0	39.8	146.0	45.8		TV255153010_	6.5	283	546
153.0	54.2	146.0	60.2		TV255153014_	9.2	396	765
173.0	39.8	166.0	45.8		TV255173010_	7.3	308	595
173.0	54.2	166.0	60.2		TV255173014_	10.3	431	833
173.0	68.6	166.0	74.6		TV255173018_	13.2	555	1 071
203.0	39.8	196.0	45.8		TV255203010_	8.5	358	691
203.0	54.2	196.0	60.2		TV255203014_	11.9	501	968
203.0	68.6	196.0	74.6		TV255203018_	15.4	644	1 244

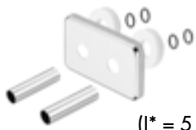
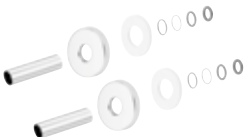
Optional

 <p>(P* = 202)</p>		 <p>(I* = 5 cm)</p>		
<p>Angled Valve Vanne équerre Eckausführung Ventil Válvula a escuadra</p> <p>[BIAN] E12SQB [CROM] E12SQR</p>	<p>Thermostatic head Tête thermostatique Thermostatkopf Cabezal termostático</p> <p>[BIAN] TTB [CROM] TTR</p>	<p>Sleeving kit Kit couvre tuyau Rosetten Kit cubre tubo</p> <p>[BIAN] C5B [CROM] C5R</p>	<p>$\varnothing \leq 16$ mm [BIAN] CTB [CROM] CTR</p> <p>$16 \text{ mm} < \varnothing < 24$ mm [BIAN] CWB [CROM] CWR</p>	<p>Tif 39,8 [CROM] MTS39R [COLOUR] MTS39C [GOLD] MTS39G</p> <p>Tif 54,2 [CROM] MTS54R [COLOUR] MTS54C [GOLD] MTS54G</p>

art* = item / modèle / Artikel / artículo I* = pipe centres / distance entre depart et retour / Achsabstand / distancia entre las conexiones
 Lt* = water content for each element / volume d'eau pour chaque element / Wassergehalt für Element / contenido de agua por cada elemento
 P* = page / page / Seite / página



Kcal = Watt x 0.860
BTU = Watt x 3.413

Watt Δt 60° = Watt Δt 50° x 1.264
Watt Δt 40° = Watt Δt 50° x 0.750
Watt Δt 30° = Watt Δt 50° x 0.518
Watt Δt 20° = Watt Δt 50° x 0.307

p max = 10.0 bar

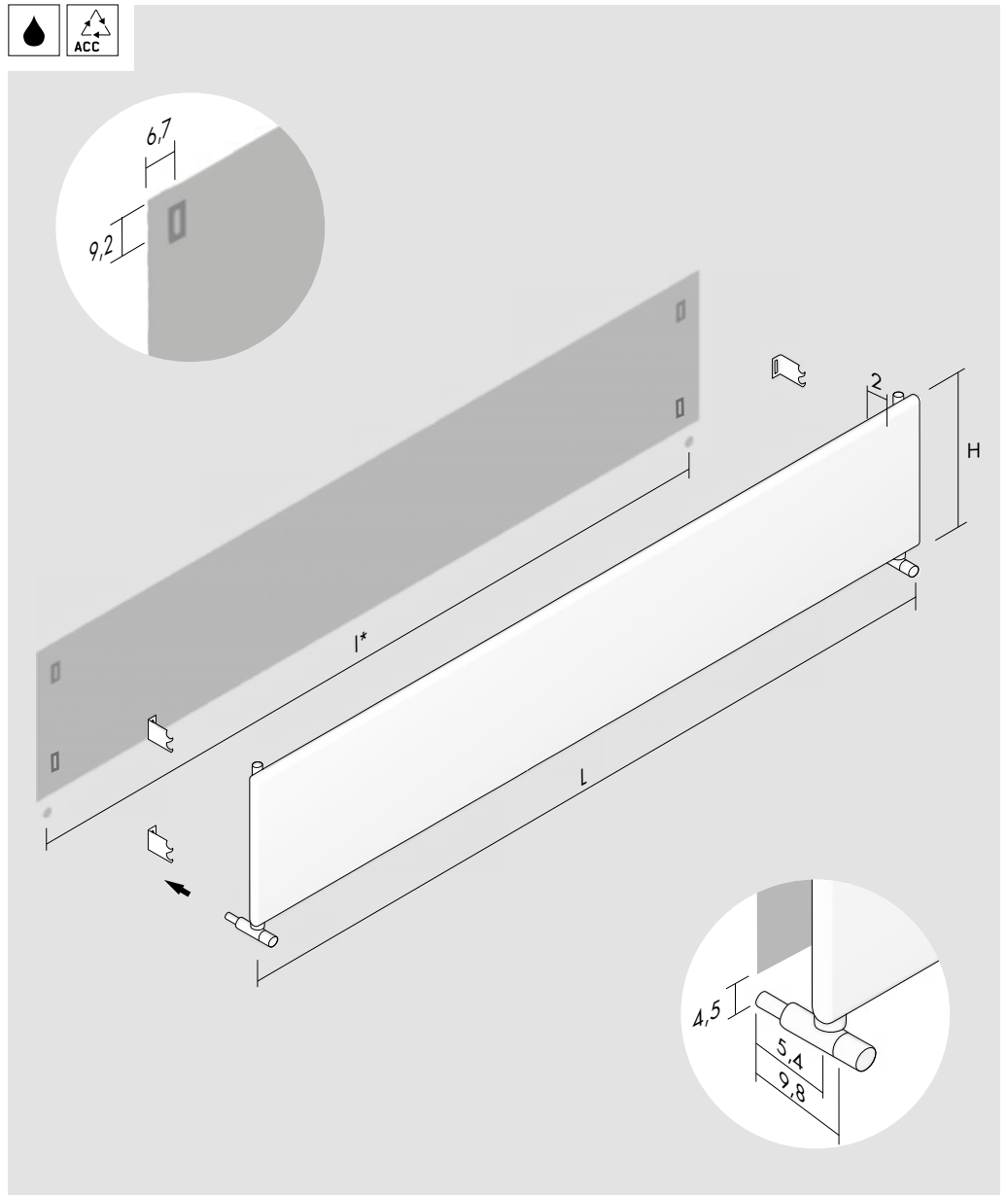

Standard connection / Raccord standard
Standard Anschluss / Conexión estándar

[X]

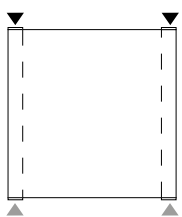

[XM_]

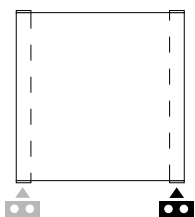

Special connection / Raccord spéciale / Speziell Anschluss / Conexión especial

[C_]

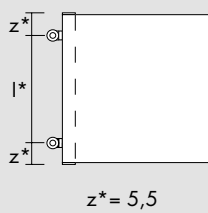

$z^* = 5,5$

[E_]

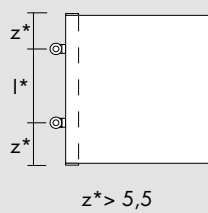

$z^* > 5,5$

[G_]

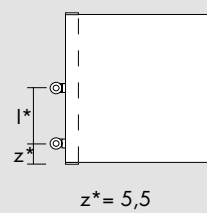

$z^* = 5,5$

[M_]

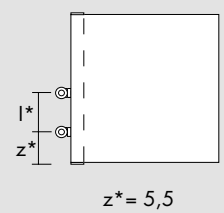

$z^* = 5,5$

[C5_]

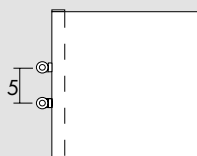

[G5_]

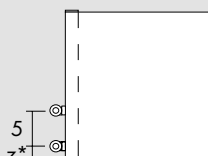

$z^* = 5,5$

[M5_]

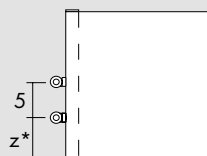

$z^* > 5,5$

Replace _ with connection S (Left) or D (Right). / Remplacer le _ avec raccordement S (Gauche) ou D (Droite). / Um linker oder rechter Anschluss zu bestellen, bitte das Symbol _ mit S (links) oder D (rechts) ersetzen. / Sustituir el _ con las conexiones S (Izquierda) o D (Derecha).

l* = pipe centres / distance entre depart et retour / Achsabstand / distancia entre las conexiones

H cm	L cm				art*	Lt*	watt Δt 30°	watt Δt 50°
39.8	103.0	96.0	45.8		TO25S103010_	4.6	178	344
39.8	123.0	116.0	45.8		TO25S123010_	5.4	214	413
39.8	153.0	146.0	45.8		TO25S153010_	6.5	268	517
39.8	173.0	166.0	45.8		TO25S173010_	7.3	303	585
39.8	203.0	196.0	45.8		TO25S203010_	8.5	357	689
54.2	103.0	96.0	60.2		TO25S103014_	6.4	250	482
54.2	123.0	116.0	60.2		TO25S123014_	7.5	299	578
54.2	153.0	146.0	60.2		TO25S153014_	9.2	375	723
54.2	173.0	166.0	60.2		TO25S173014_	10.3	425	820
54.2	203.0	196.0	60.2		TO25S203014_	11.9	499	964
68.6	173.0	166.0	74.6		TO25S173018_	13.2	546	1 054
68.6	203.0	196.0	74.6		TO25S203018_	15.4	642	1 239

Optional



(P* = 202)

Angled Valve
 Vanne équerre
 Eckausführung Ventil
 Válvula a escuadra

[BIAN] **E12SQB**
 [CROM] **E12SQR**



Thermostatic head
 Tête thermostatique
 Thermostatkopf
 Cabezal termostático

[BIAN] **TTB**
 [CROM] **TTR**

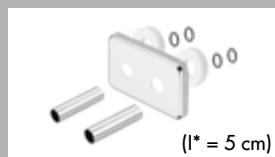

(l* = 5 cm)

Sleeving kit
 Kit couvre tuyau
 Rosetten
 Kit cubre tubo

[BIAN] **C5B**
 [CROM] **C5R**

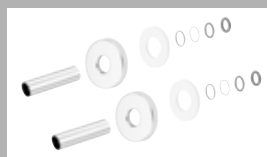

$\varnothing \leq 16$ mm
 [BIAN] **CTB**
 [CROM] **CTR**

16 mm $< \varnothing < 24$ mm
 [BIAN] **CWB**
 [CROM] **CWR**

art* = item / modèle / Artikel / artículo l* = pipe centres / distance entre depart et retour / Achsabstand / distancia entre las conexiones
 Lt* = water content for each element / volume d'eau pour chaque element / Wassergehalt für Element / contenido de agua por cada elemento
 P* = page / page / Seite / página



Kcal = Watt x 0.860
BTU = Watt x 3.413

Watt Δt 60° = Watt Δt 50° x 1.264
Watt Δt 40° = Watt Δt 50° x 0.750
Watt Δt 30° = Watt Δt 50° x 0.518
Watt Δt 20° = Watt Δt 50° x 0.307

p max = 10.0 bar

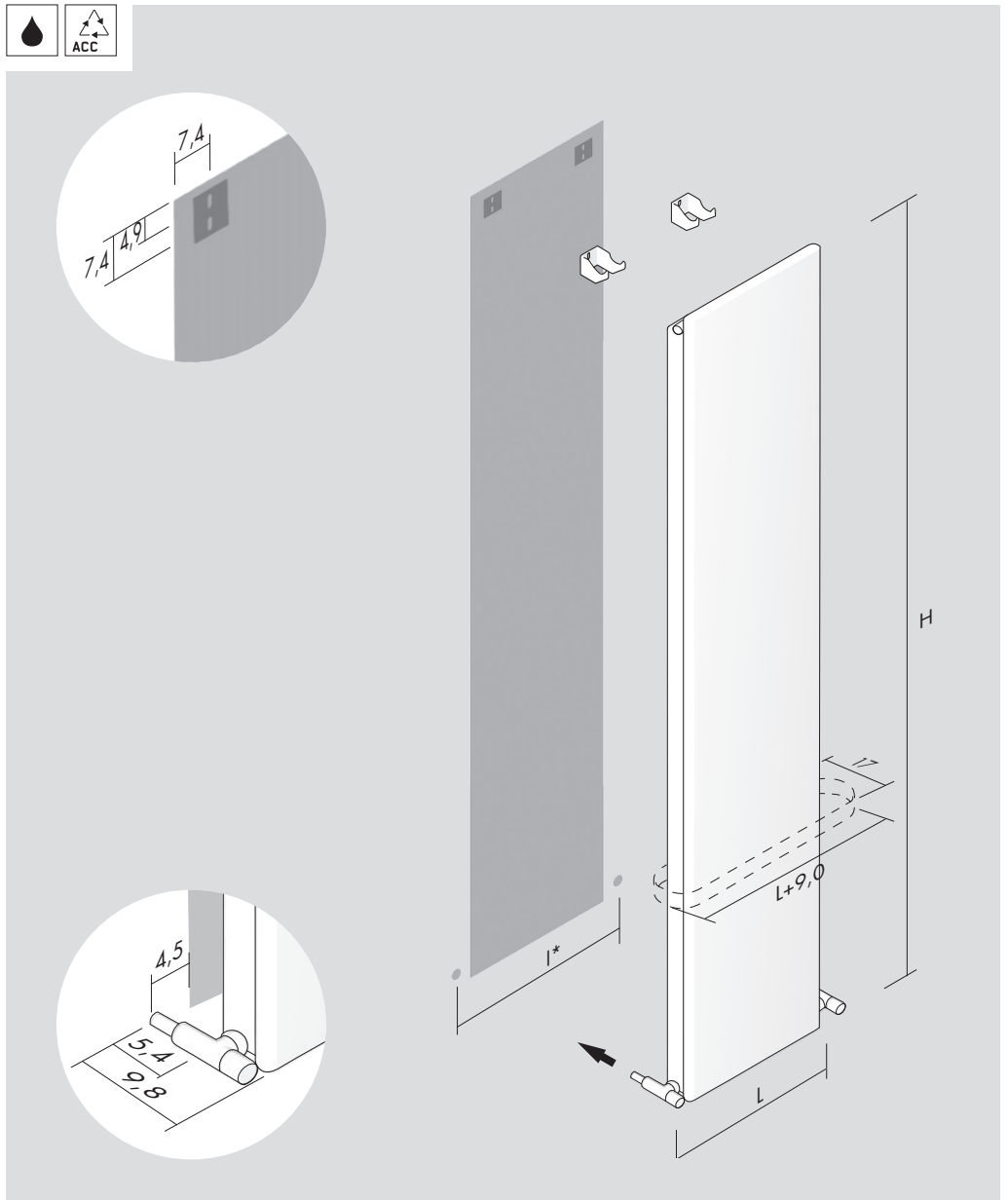

Standard connection / Raccord standard
Standard Anschluss / Conexión estándar

[X]

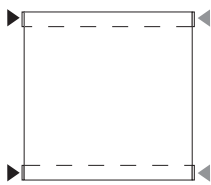

[XM_]

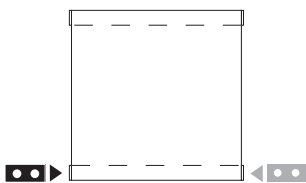

Special connection / Raccord spéciale / Speziell Anschluss / Conexión especial

[B]

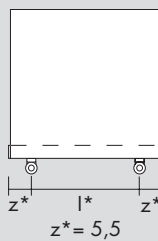

[E]

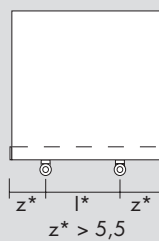

[S]

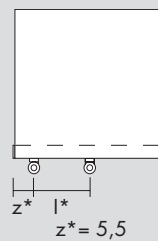

[D]

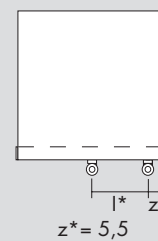

[PS]

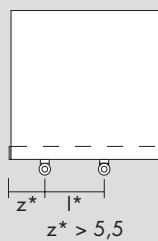

[PD]

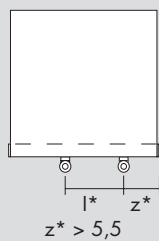

[5]

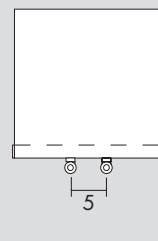

[5_]

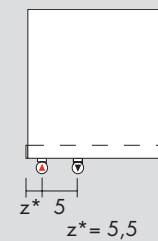

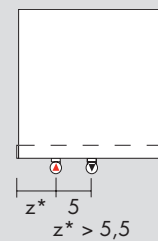

[P5_]



Replace _ with connection S (Left) or D (Right). / Remplacer le _ avec raccordement S (Gauche) ou D (Droite). / Um linker oder rechter Anschluss zu bestellen, bitte das Symbol _ mit S (links) oder D (rechts) ersetzen. / Sustituir el _ con las conexiones S (Izquierda) o D (Derecha).

l* = pipe centres / distance entre depart et retour / Achsabstand / distancia entre las conexiones

H cm	L cm				art*	Lt*	watt Δt 30°	watt Δt 50°
63.0	83.0	56.0	89.0		TV25D063022_	11.8	495	955
103.0	39.8	96.0	45.8		TV25D103010_	8.5	347	669
103.0	54.2	96.0	60.2		TV25D103014_	11.9	486	938
123.0	39.8	116.0	45.8		TV25D123010_	10.1	405	781
123.0	54.2	116.0	60.2		TV25D123014_	14.2	567	1 094
153.0	39.8	146.0	45.8		TV25D153010_	12.5	488	943
153.0	54.2	146.0	60.2		TV25D153014_	17.5	684	1 320
173.0	39.8	166.0	45.8		TV25D173010_	14.1	542	1 047
173.0	54.2	166.0	60.2		TV25D173014_	19.7	760	1 467
173.0	68.6	166.0	74.6		TV25D173018_	25.4	977	1 886
203.0	39.8	196.0	45.8		TV25D203010_	16.5	622	1 200
203.0	54.2	196.0	60.2		TV25D203014_	23.1	870	1 680
203.0	68.6	196.0	74.6		TV25D203018_	29.7	1 119	2 160

Optional



(P* = 202)

Angled Valve
Vanne équerre
Eckausführung Ventil
Válvula a escuadra

[BIAN] **E12SQB**
[CROM] **E12SQR**



Thermostatic head
Tête thermostatique
Thermostatkopf
Cabezal termostático

[BIAN] **TTB**
[CROM] **TTR**

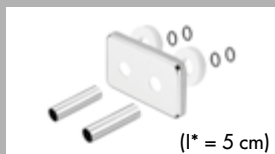

(I* = 5 cm)

Sleeving kit
Kit couvre tuyau
Rosetten
Kit cubre tubo

[BIAN] **C5B**
[CROM] **C5R**

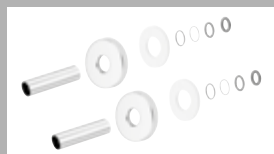
 $\varnothing \leq 16$ mm

[BIAN] **CTB**
[CROM] **CTR**

 $16 \text{ mm} < \varnothing < 24$ mm

[BIAN] **CWB**
[CROM] **CWR**

**Tif 39,8**

[CROM] **MTD39R**
[COLOUR] **MTD39C**
[GOLD] **MTD39G**

Tif 54,2

[CROM] **MTD54R**
[COLOUR] **MTD54C**
[GOLD] **MTD54G**

art* = item / modèle / Artikel / artículo I* = pipe centres / distance entre depart et retour / Achsabstand / distancia entre las conexiones
Lt* = water content for each element / volume d'eau pour chaque element / Wassergehalt für Element / contenido de agua por cada elemento
P* = page / page / Seite / página



Kcal = Watt x 0.860
BTU = Watt x 3.413

Watt Δt 60° = Watt Δt 50° x 1.264
Watt Δt 40° = Watt Δt 50° x 0.750
Watt Δt 30° = Watt Δt 50° x 0.518
Watt Δt 20° = Watt Δt 50° x 0.307

p max = 10.0 bar

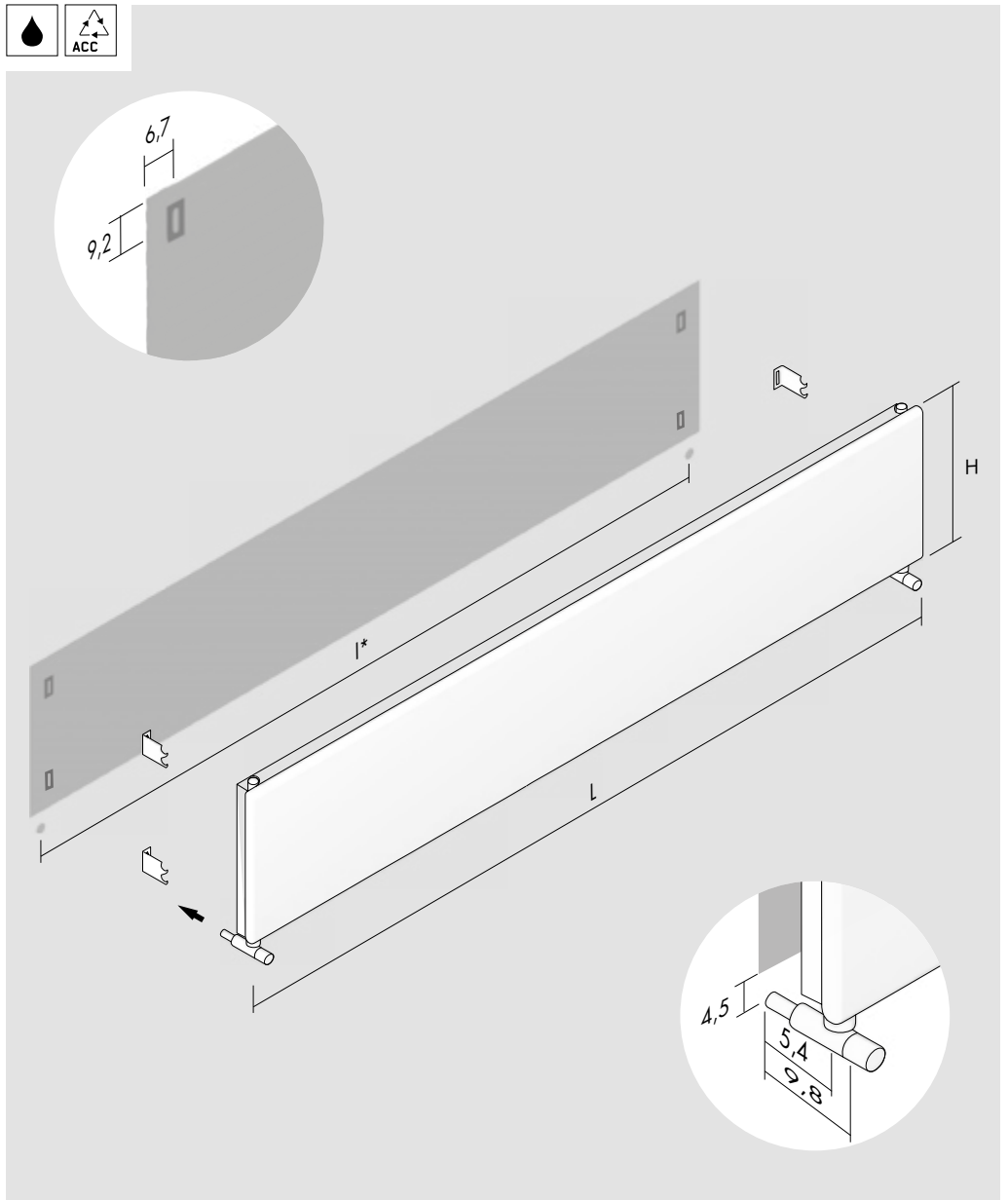

Standard connection / Raccord standard
Standard Anschluss / Conexión estándar

[X]

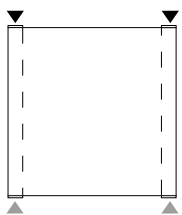

[XM_]

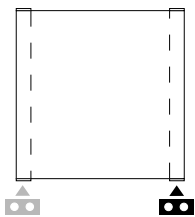

Special connection / Raccord spéciale / Speziell Anschluss / Conexión especial

[C_]

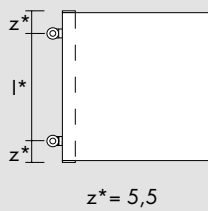

$z^* = 5,5$

[E_]

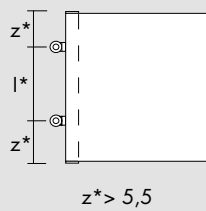

$z^* > 5,5$

[G_]

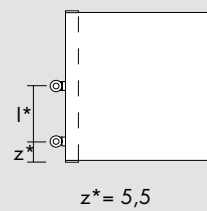

$z^* = 5,5$

[M_]

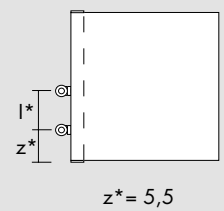

$z^* = 5,5$

[C5_]

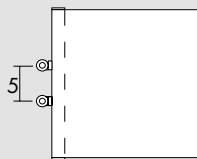

[G5_]

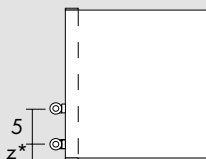

$z^* = 5,5$

[M5_]

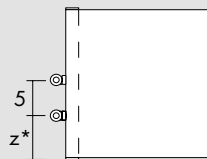

$z^* > 5,5$

Replace _ with connection S (Left) or D (Right). / Remplacer le _ avec raccordement S (Gauche) ou D (Droite). / Um linker oder rechter Anschluss zu bestellen, bitte das Symbol _ mit S (links) oder D (rechts) ersetzen. / Sustituir el _ con las conexiones S (Izquierda) o D (Derecha).

l* = pipe centres / distance entre depart et retour / Achsabstand / distancia entre las conexiones

H cm	L cm				art*	Lt*	watt Δt 30°	watt Δt 50°
39.8	103.0	96.0	45.8		TO25D103010_	8.5	317	612
39.8	123.0	116.0	45.8		TO25D123010_	10.1	381	735
39.8	153.0	146.0	45.8		TO25D153010_	12.5	476	919
39.8	173.0	166.0	45.8		TO25D173010_	14.1	539	1 041
39.8	203.0	196.0	45.8		TO25D203010_	16.5	635	1 225
54.2	103.0	96.0	60.2		TO25D103014_	11.9	429	829
54.2	123.0	116.0	60.2		TO25D123014_	14.2	515	995
54.2	153.0	146.0	60.2		TO25D153014_	17.5	644	1 244
54.2	173.0	166.0	60.2		TO25D173014_	19.7	730	1 409
54.2	203.0	196.0	60.2		TO25D203014_	23.1	859	1 658
68.6	63.0	56.0	74.6		TO25D063018_	9.6	329	635
68.6	83.0	76.0	74.6		TO25D083018_	12.5	438	845
68.6	103.0	96.0	74.6		TO25D103018_	15.4	547	1 056
68.6	123.0	116.0	74.6		TO25D123018_	18.2	656	1 267
68.6	153.0	146.0	74.6		TO25D153018_	22.5	821	1 584
68.6	173.0	166.0	74.6		TO25D173018_	25.4	930	1 795
68.6	203.0	196.0	74.6		TO25D203018_	29.7	1 094	2 112

Optional



(P* = 202)

Angled Valve
 Vanne équerre
 Eckausführung Ventil
 Válvula a escuadra

[BIAN] **E12SQB**
 [CROM] **E12SQR**



Thermostatic head
 Tête thermostatique
 Thermostatkopf
 Cabezal termostático

[BIAN] **TTB**
 [CROM] **TTR**

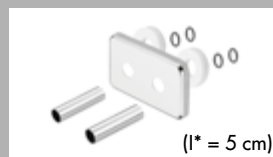

(l* = 5 cm)

Sleeving kit
 Kit couvre tuyau
 Rosetten
 Kit cubre tubo

[BIAN] **C5B**
 [CROM] **C5R**

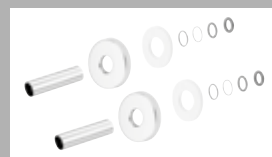

$\varnothing \leq 16$ mm
 [BIAN] **CTB**
 [CROM] **CTR**

$16 \text{ mm} < \varnothing < 24$ mm
 [BIAN] **CWB**
 [CROM] **CWR**

art* = item / modèle / Artikel / artículo l* = pipe centres / distancia entre depart et retour / Achsabstand / distancia entre las conexiones
 Lt* = water content for each element / volume d'eau pour chaque element / Wassergehalt für Element / contenido de agua por cada elemento
 P* = page / page / Seite / página